

MTS70-TH

POWER RECTIFIER BRIDGE

Output Current **70 A**

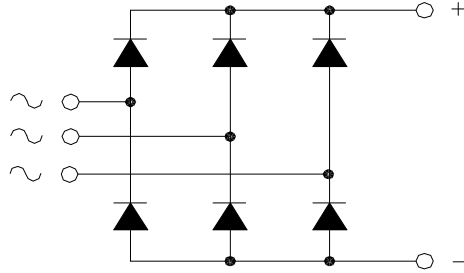

V_{RRM}	V_{RSM}	P/N
1600	1700	MTS70.16-TH

Features

Low forward voltage diodes for high surge capability
 Low thermal impedance packaging
 Electrically insulated case

Applications

Input rectifier for variable frequency drives
 Battery charger rectifiers
 Single phase rectifier for power supplies
 Rectifiers for DC motor fields supplies

Diodes characteristics		Conditions	T_j [°C]	Value
I_{RRM}	Max repetitive peak reverse current	$V = V_{RRM}$	150	4 mA
$V_{F(TO)}$	Threshold voltage		150	0,9 V
r_F	Forward slope resistance		150	7,0 mΩ
V_{FM}	Peak forward voltage, max	$I_F = 100A$	25	1,7 V
I_{FSM}	Surge forward current	Half sine wave, 10 ms	150	700 A
I^2t	Max I^2t for fusing		150	2450 A ² s
T_{jmax}	Operating junction temperature			-40 / 150 °C
$R_{th(j-c)}$	Thermal resistance (junction to case)	DC operation		1,02 °C/W
$R_{th(j-c)}$	Thermal resistance (junction to case)	Rectangular wave 120° conduction		1,14 °C/W

Module characteristics		Conditions	Value
I_D	DC output current	$T_c = 112$ °C	70 A
I_D	DC output current	$T_a = 40$ °C ; freely suspended	6 A
V_{INS}	RMS Insulating voltage	50 / 60 Hz $t = 1$ s ($i < 1$ mA)	3600 V
V_{INS}	RMS Insulating voltage	50 / 60 Hz $t = 60$ s ($i < 1$ mA)	3000 V
$R_{th(j-c)}$	Thermal resistance (junction to case)	DC operation	0,174 °C/W
$R_{th(j-c)}$	Thermal resistance (junction to case)	Rect. wave 120° conduction	0,193 °C/W
$R_{th(c-h)}$	Thermal resistance (case to heatsink)	Mounting surface flat, smooth and greased	0,100 °C/W
$R_{th(j-a)}$	Thermal resistance (junction to ambient)	Freely suspended or mounted on an insulator	9,0 °C/W
$R_{th(j-a)}$	Thermal resistance (junction to ambient)	Mounted on a painted metal sheet 250x250x1 mm	3,5 °C/W
T_{stg}	Max storage temperature		150 °C
M_1	Mounting torque, ± 15 %		4,5 N·m 40 lb·inch

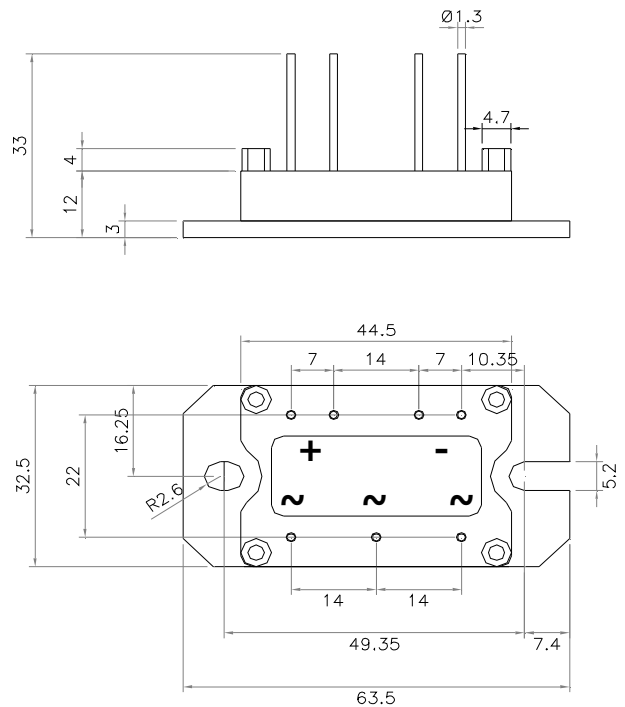
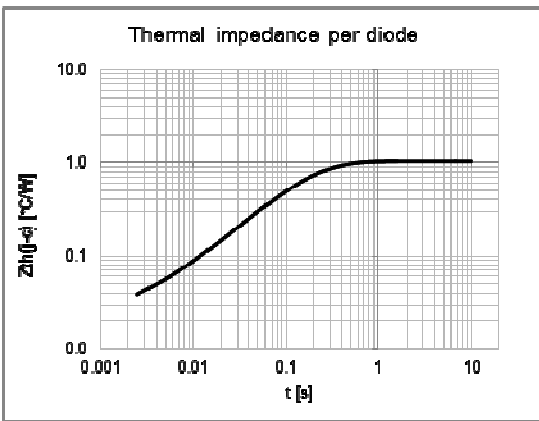
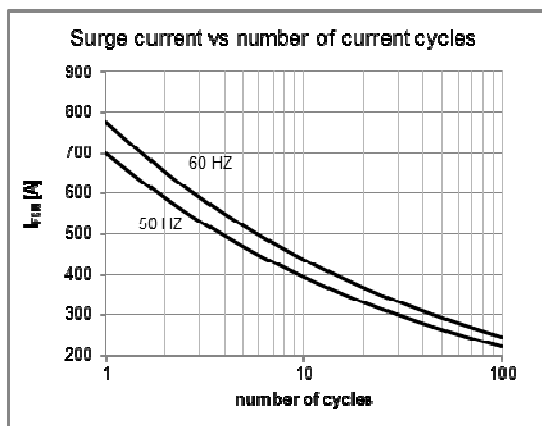
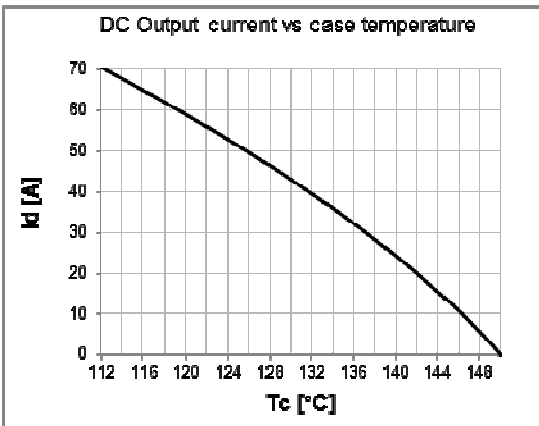
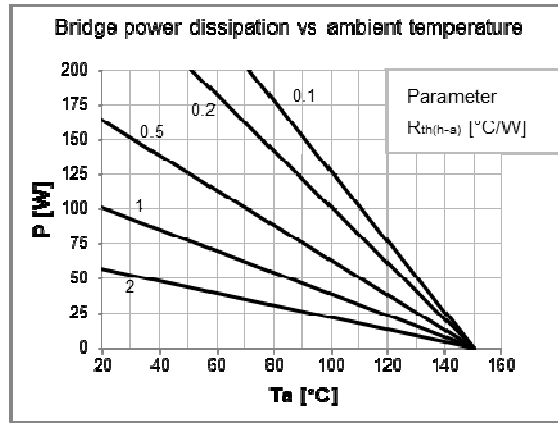
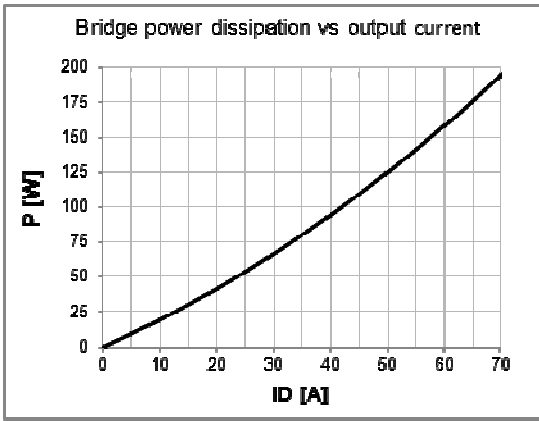

Notes :

To reduce the thermal resistance we recommend to apply a layer of 100..200µm of thermal compound to the heat sink or to the module base.

The flatness tolerance of IMS is 80µm.

MTS70.16-LL-FIX5-LP-P49,35-TH
Code:970000700040

Scomes srl reserves the right to change any specification without notice

S.CO.M.E.S. srl Via Enrico Mattei,6/8 26823 Castiglione d'Adda(LO)-IT

issue:mar-2017

Phone:+39 0377 901243 Fax:+39 0377 900206