

## MTS200.16

### Power Rectifier bridge

#### Features:

- International standard package
- Low forward voltage drop
- Isolation voltage 2500V ~
- Simple mounting
- UL recognized, file no. E312789

#### Typical applications:

- DC power suppliers for apparatus device
- Input rectifying power supply for PWM converters
- Inverter welders
- Battery chargers

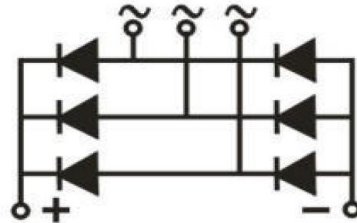

Symbol	Characteristics	Test Conditions	Value			Unit
			Min	Typ	Max	
$V_{RSM/DSM}$	Non-repetitive reverse/forward blocking voltage	$T_j = 25^\circ\text{C}$			1700	V
$V_{RRM/DRM}$	Repetitive reverse/forward blocking voltage	$T_j = 25^\circ\text{C}$			1600	V
$I_D$	Rectifier bridge output current	Three-phase whole wave rectifying circuit, $T_c = 100^\circ\text{C}$			200	A
$I_{RRM}$	Repetitive peak reverse current	at $V_{RRM}$ $T_j = 150^\circ\text{C}$			8	mA
$I_{FSM}$	Forward surge current	10ms half sine wave, $T_j = 150^\circ\text{C}$			2600	A
$I^2 t$	$I^2 t$ for fusing coordination	$V_R = 0.6 V_{RRM}$ , $T_j = 150^\circ\text{C}$			33800	$\text{A}^2\text{s}$
$V_{FO}$	Threshold voltage	$T_j = 150^\circ\text{C}$			0.85	V
$r_T$	Forward slope resistance	$T_j = 150^\circ\text{C}$			3	$\text{m}\Omega$
$V_{FM}$	Peak forward voltage	$T = 25^\circ\text{C}$ ; $I_T = 200\text{A}$		1.00	1.20	V
$R_{th(j-c)}$	Thermal resistance junction to case	per module			0.086	$^\circ\text{C}/\text{W}$
$R_{th(c-s)}$	Thermal resistance case to sink	per module			0.03	$^\circ\text{C}/\text{W}$
$V_{ISO}$	Isolation voltage	50Hz, RMS, $t = 1\text{min}$			2500	V
$F_M$	Mounting torque - copper plate (M6)		4		6	N·m
	Mounting torque - terminal (M6)		4		6	N·m
$T_{stg}$	Storage Temperature		-40		150	$^\circ\text{C}$
$T_j$	Operating Temperature		-40		150	$^\circ\text{C}$
$W_t$	Weight			320		g
Outline	M23					

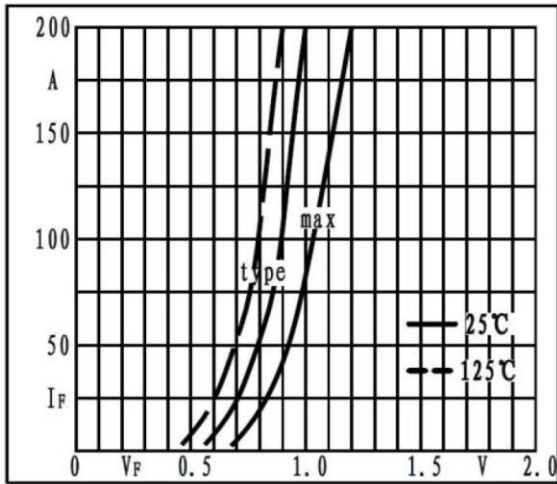

Fig1. Forward characteristics

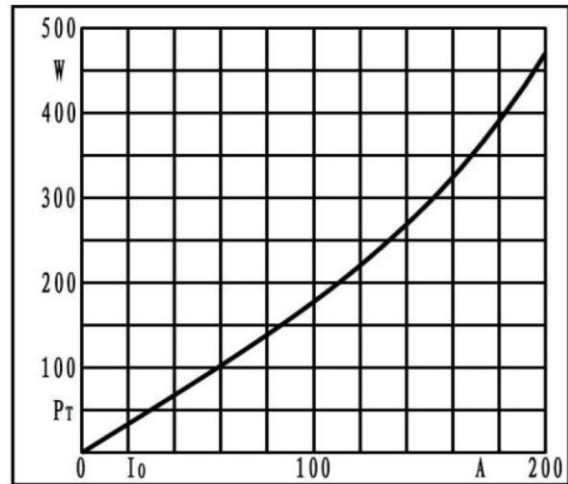

Fig2. Power dissipation

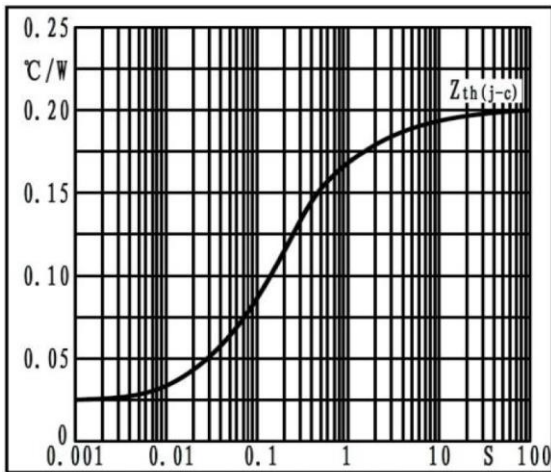

Fig3. Transient thermal impedance

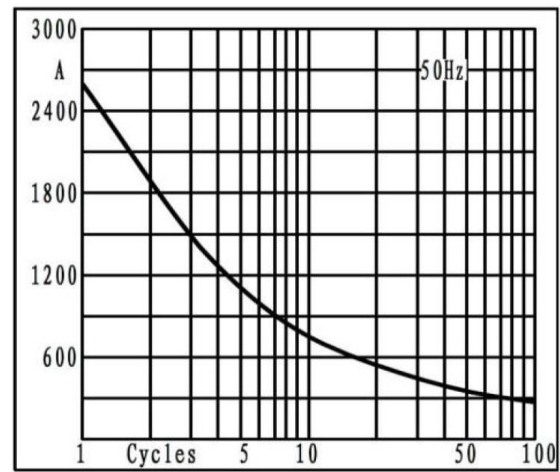

Fig4. Max non-repetitive forward surge current

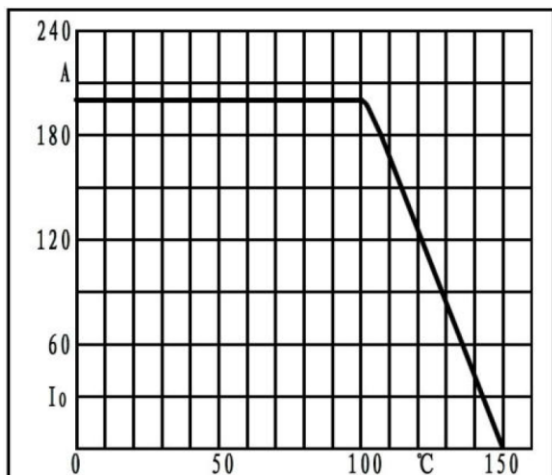
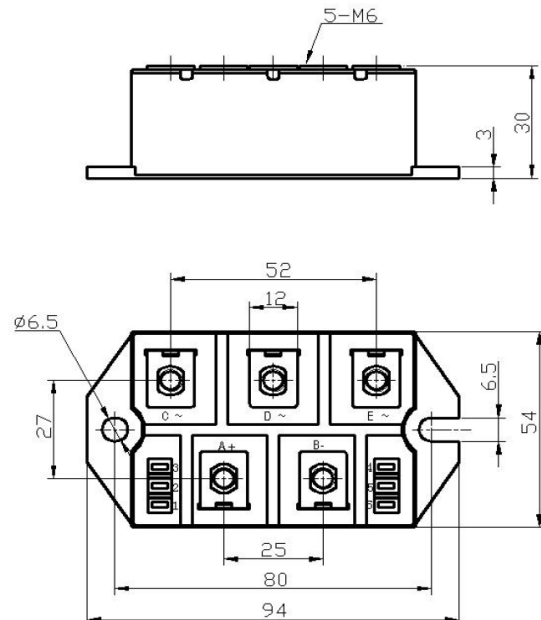

Fig5. Forward current derating curve



### S.CO.M.E.S. Srl

Via Enrico Mattei, 6/8 - 26283 - Castiglione d'Adda (LO) - Italy

Phone: +39 0377 901243 Fax: +39 0377 900206